

# Data Sheet

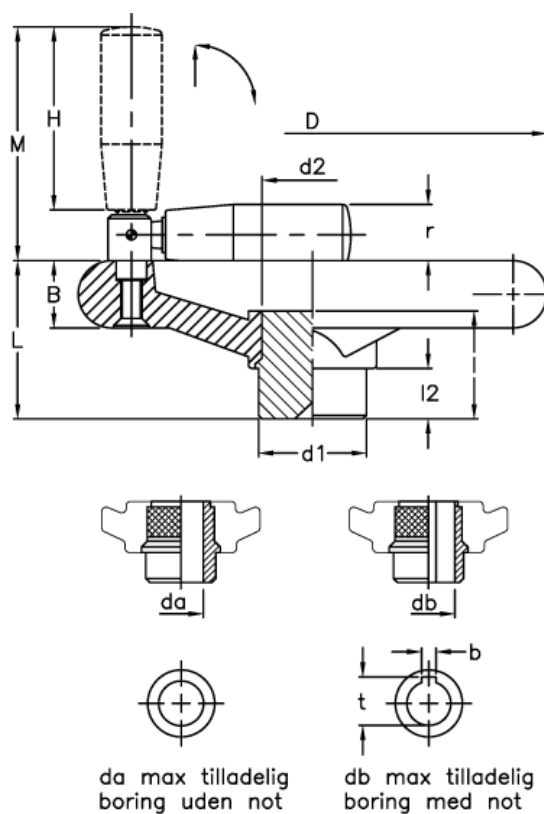

Article number: 2301077831  
Description: E+G Handwheel  
VR.300 FP+IR

## Measures



B	= 32	H	= 90	t = 37.3
b	= 10	l	= 56	
C (N m)	= 800	L	= 78	
D	= 288	L (J)	= 33	
d1	= 58	l2	= 18	
d2	= 47	M	= 113	
da	= 42	r	= 27	
db	= 34	R	= 113	